



DYNACO D-311

**Gravity
driven**

low friction technology



inside door

DYNACO D-311

The DYNACO D-311 LF is designed for inside applications. It requires little space and protects your environment against drafts, humidity, dust and dirt. Operating speed and superior sealing properties improve your traffic flows and provide employee comfort, environmental control and savings on energy costs.

The patented «LF» (Low Friction) technology, combined with a frequency inverter driven motor, assures a smooth operation.

- **OPENING SPEED:**
Up to 2,0 m/s.
- **SUPERIOR SEAL:**
The patented side guides and «BEAD» technology allow energy savings.
- **CRASH FORGIVING AND SELF-REINSERTING WITHOUT INTERVENTION:**
The curtain automatically reinserts itself when dislodged. No repair costs, no production down time.
- **USER SAFETY:**
Flexible curtain without rigid elements.
- **COMFORT OF USE:**
DYNACO wireless detector at the bottom.
- **ADVANCED DRIVE:**
Frequency driven motor and encoder for smooth operation and reliability. Wearable elements are reduced to a minimum.
- **DYNALOGIC CONTROL BOX:**
User-friendly control box with self-diagnosis.
- **CONFORM TO EN13241-1**

Printable curtain



Low friction side guide

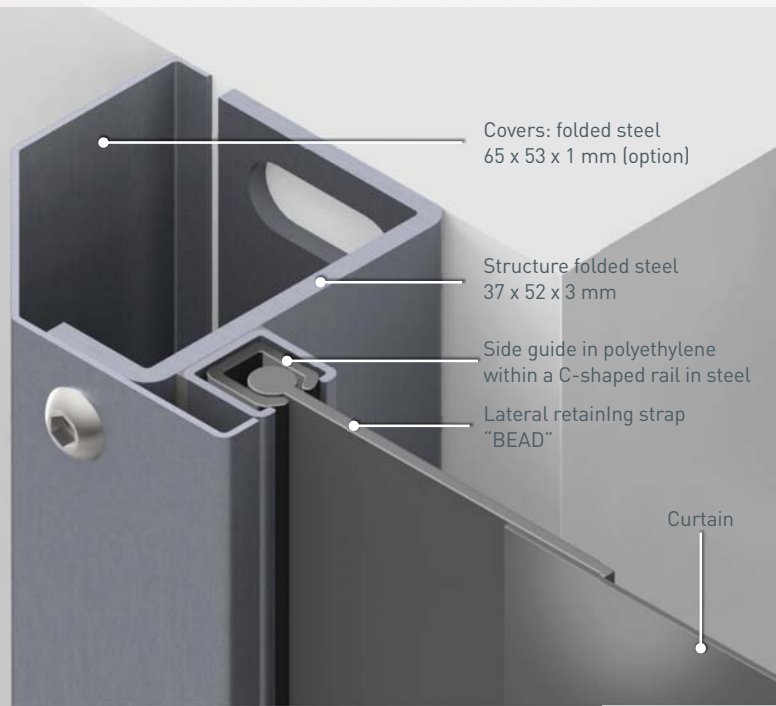

Gravity driven

low friction technology



























porte intérieure

EN13241-1 STANDARDS

Standard	Ref.	Test acc.	Results
Water permeability	EN 12425	EN 12489	Class 2
Wind load	EN 12424	EN 12444	Class 1*
Wind permeability	EN 12426	EN 12427	Class 1
Safe openings	EN 12453	EN 12445	Pass
Mechanical resistance	EN 12604	EN 12605	Pass
Unintended movements	EN 12604	EN 12605	Pass
Thermal resistance	EN 12428	EN 12428	6,02 W/m ² K
Performance (cycles)	EN 12604	EN 12605	1.000.000

* Interior applications only

CHARACTERISTICS

Max. dimensions	W 4.000 mm x H 4.000 mm																
Opening speed Closing speed	up to 1,2 m/s (optional 2,0 m/s) 0,5 m/s																
Structure	Folded steel 37 x 52 x 3 mm, galvanised before cutting and folding. Option: stainless steel																
Drum	Steel - Ø 102 x 2 mm.																
Side guides	Reinforced polyethylene (PE-UHMW1000)																
Motor	2 poles, without brake. Power 0,75 kW. IP rating: IP 65																
Control box	DYNALOGIC provided with: Circuit breaker, general divider, adjustable timer, push button for opening and reset and emergency stop. IP rating: IP 54. Frequency inverter.																
Standard detectors	Infrared barrier: 300 mm from the floor. Wireless DYNACO detector (WDD) DBD: correct unwinding detector																
Power supply Frequency	Single phase 230 V - 14 A. Frequency: 50-60 Hz																
Advised operating temperature	+ 5 °C up to + 40 °C																
Available colours comparable with:	<table border="0"> <tr> <td>Yellow RAL1003</td> <td></td> <td>Green RAL6005</td> <td></td> </tr> <tr> <td>Orange RAL2004</td> <td></td> <td>Grey RAL7035</td> <td></td> </tr> <tr> <td>Red RAL3000</td> <td></td> <td>White RAL9010</td> <td></td> </tr> <tr> <td>Blue RAL5002</td> <td></td> <td>Black RAL9005</td> <td></td> </tr> </table>	Yellow RAL1003		Green RAL6005		Orange RAL2004		Grey RAL7035		Red RAL3000		White RAL9010		Blue RAL5002		Black RAL9005	
Yellow RAL1003		Green RAL6005															
Orange RAL2004		Grey RAL7035															
Red RAL3000		White RAL9010															
Blue RAL5002		Black RAL9005															
(Actual colours may deviate. Colour samples available upon request)																	

Easy to clean

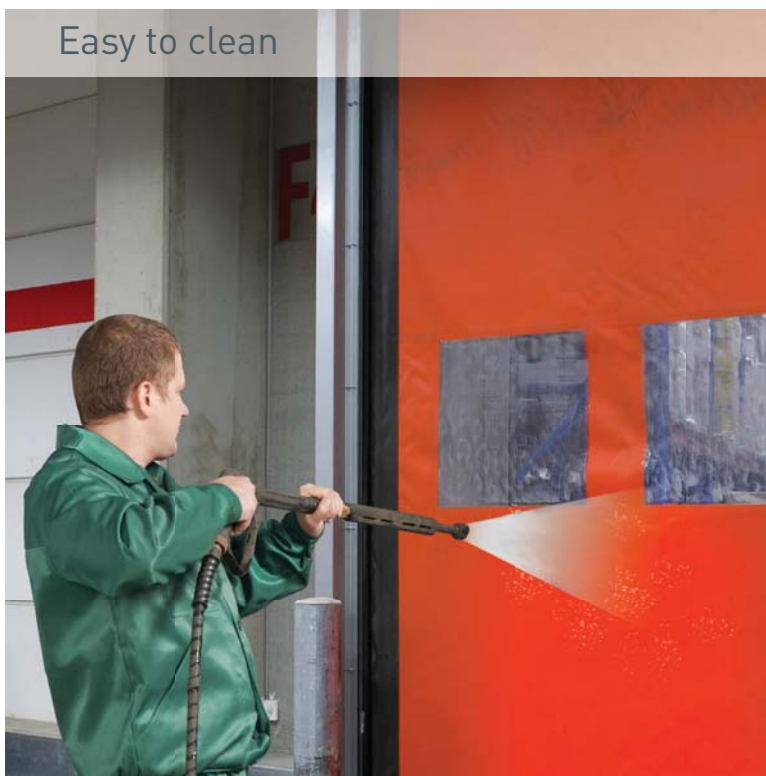

Reintroduction block^{PT}

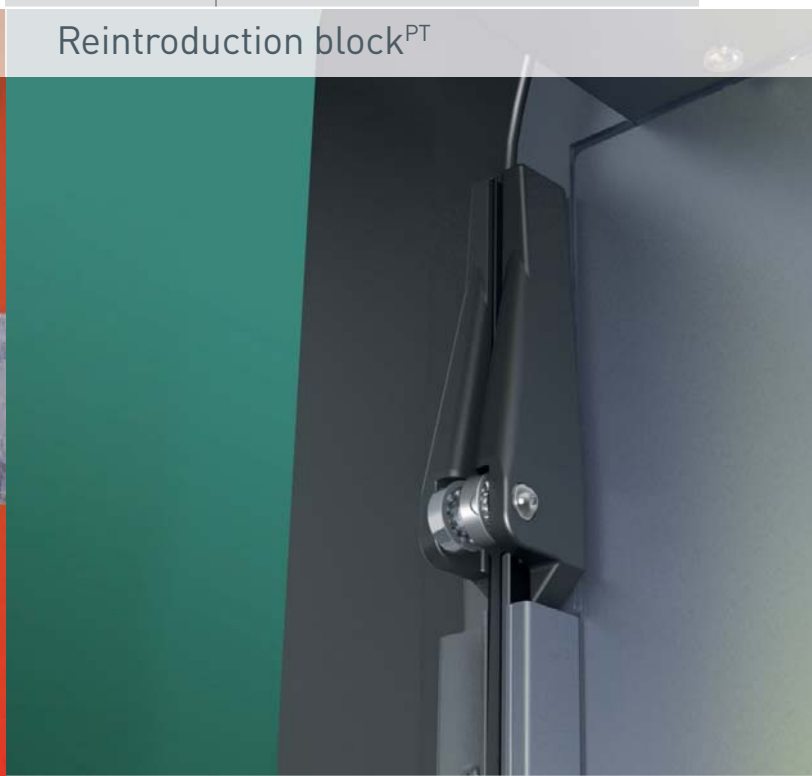

Dimensions and installation requirements DYNACO D-311

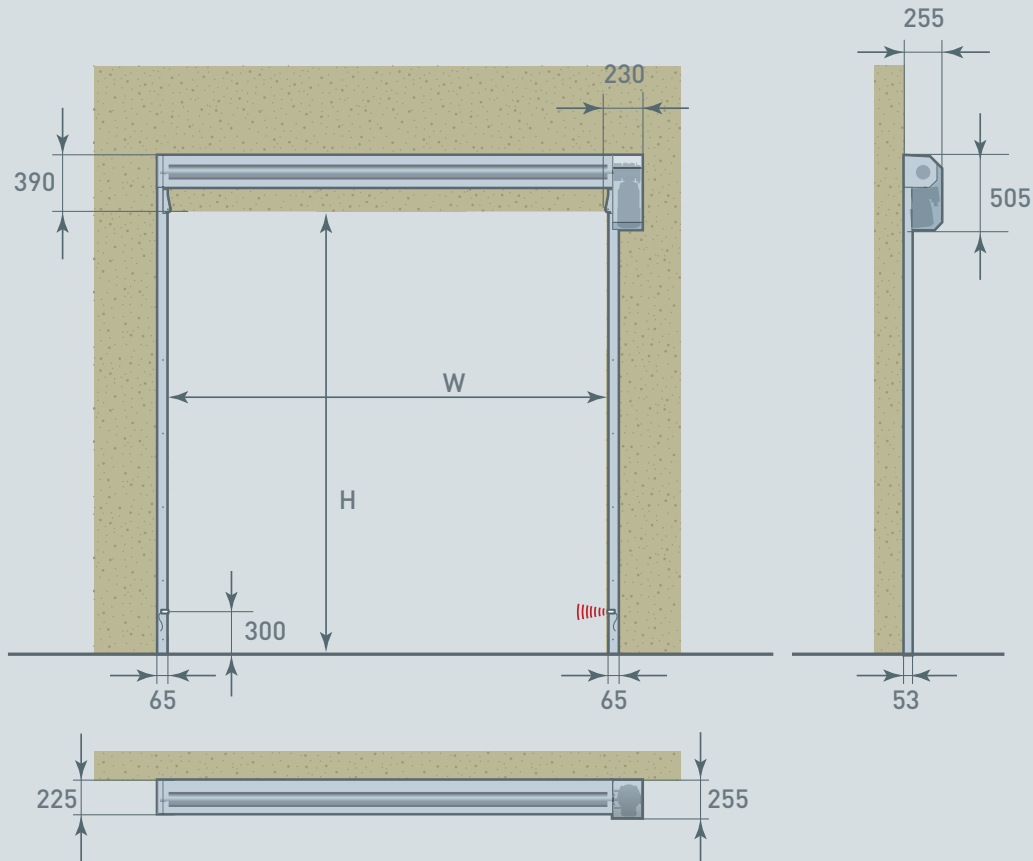

All indicated dimensions are based on exact width and height dimensions only. The space necessary for mounting and maintenance has to be provided.

REMARK: Based on the risk analysis of the environment, extra push buttons, detectors and covers might be required.

© All rights reserved by Dynaco – 2013

The DYNACO Entrematic products are protected by worldwide registered patents. As part of its policy of continuous product development, DYNACO Entrematic reserves the right to change the characteristics of its products or components without prior notice.

Disclaimers:

For a correct use of our products, please refer to our manual.

Everything that is mentioned in this brochure is only valid under the terms of use in the user manual and on condition that the door was properly installed and maintained and has not undergone abuse nor neglect.

 **DYNACO**
ENTRE//MATIC

DYNACO ENTREMATI
Waverstraat 21
B-9310 Moorsel-Aalst (Belgium)
Tel. +32 53 72 98 98
Fax. +32 53 72 98 50
info.dynaco.eu@entrematic.com
www.dynaco.eu